

Quadrax/Twinax Connector Series

MIL-DTL-38999 Style Connectors

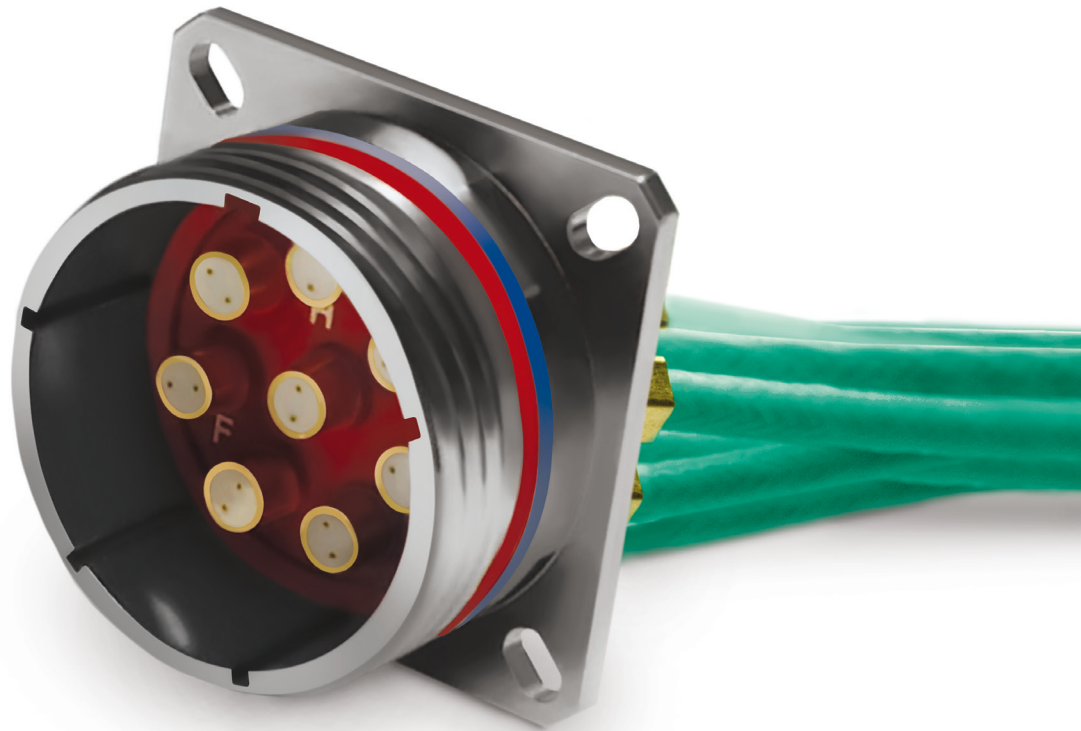

Quadrax and Twinax Connectors

MIL-DTL-38999 Twinax/Quadrax Plug

Shell Size	B Dia. +.008 -0	K Max	S Dia. Max	Z Max
9	0.724	0.748	0.858	1.220
11	0.831	0.862	0.984	
13	1.000	1.028	1.157	
15	1.130	1.154	1.280	
17	1.268	1.291	1.406	
19	1.374	1.398	1.516	
21	1.500	1.524	1.642	
23	1.618	1.642	1.768	
25	1.744	1.768	1.890	

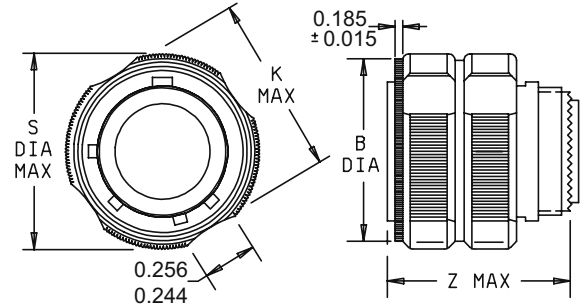

MIL-DTL-38999 Twinax/Quadrax Receptacle

Shell Size	C Thread .1 Pitch .3 Lead	P ±.008	R1 BSC	R2 BSC	V Max +0.00 -0.005	W Max	PP Max ±.008	S ±.012
9	0.625	0.128	0.719	0.594	0.820	0.098	0.216	0.937
11	0.750		0.812	0.719			0.194	1.031
13	0.875		0.906	0.812			0.173	1.126
15	1.000		0.969	0.906			0.194	1.220
17	1.188		1.062	0.969			0.194	1.311
19	1.250		1.156	1.062			0.194	1.437
21	1.375	0.154	1.250	1.156	0.790	0.126	0.242	1.563
23	1.500		1.375	1.250			0.242	1.689
25	1.625		1.500	1.375			0.242	1.811

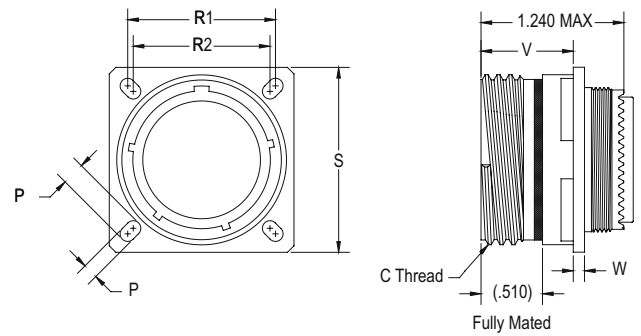

Size 8 Quadrax Contacts

Size 8 Quadrax Pin Contact 100 Ohm

Part Number	Ohms	Cable Type	Cable
019635-0001	100	Differential Quad	540-1183-000
019635-0010	100	Differential Quad	540-1209-000

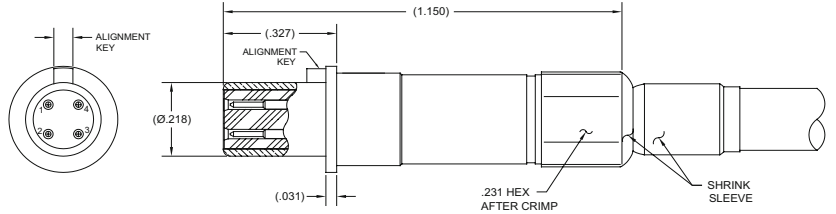

Size 8 Quadrax Socket Contact 100 Ohm

Part Number	Ohms	Cable Type	Cable
019535-0001	100	Differential Quad	540-1183-000
019535-0010	100	Differential Quad	540-1209-000

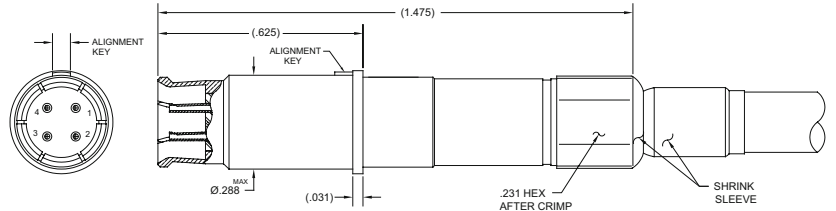

Size 8 Quadrax/Twinax Receptacle PC Tail Configuration

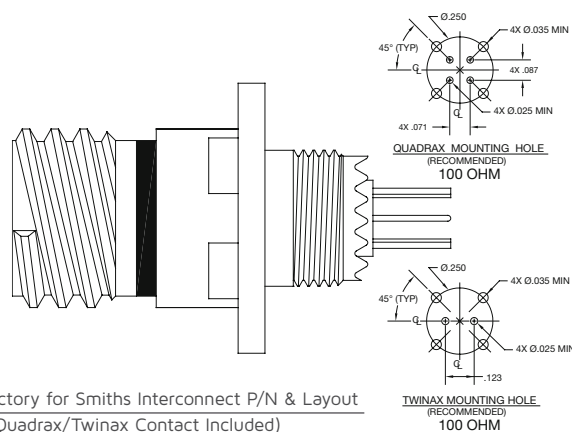

Consult Factory for Smiths Interconnect P/N & Layout
(Quadrax/Twinax Contact Included)

Size 8 Twinax Contacts

Size 8 Twinax Pin Contact 100 Ohm

Part Number	Cable Type	Cable
019634-0011	Differential Twinax	540-1167-000
019634-0012	Flexible Twinax	540-1161-000
019634-0013	Differential Twinax	540-1153-000

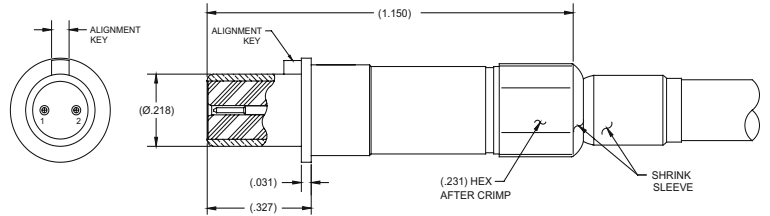

Size 8 Twinax Socket Contact 100 Ohm

Part Number	Cable Type	Cable
019534-0011	Differential Twinax	540-1167-000
019534-0012	Flexible Twinax	540-1161-000
019534-0013	Differential Twinax	540-1153-000

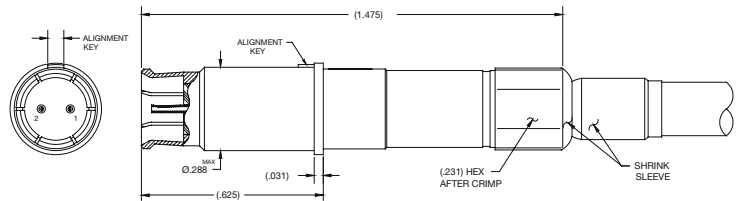

Size 8 Twinax Pin Contact 150 Ohm

Part Number	Cable Type	Cable
019634-0014	Differential Twinax	540-1099-000
019634-0020	Differential Twinax	540-1236-000

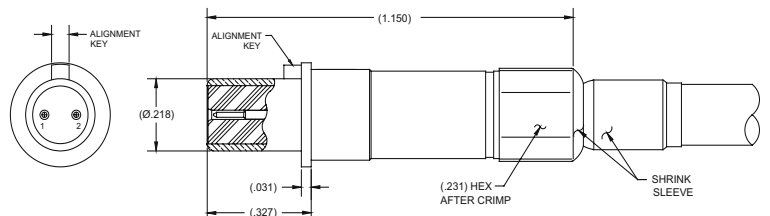

Size 8 Twinax Socket Contact 150 Ohm

Part Number	Cable Type	Cable
019534-0014	Differential Twinax	540-1099-000
019534-0020	Differential Twinax	540-1236-000

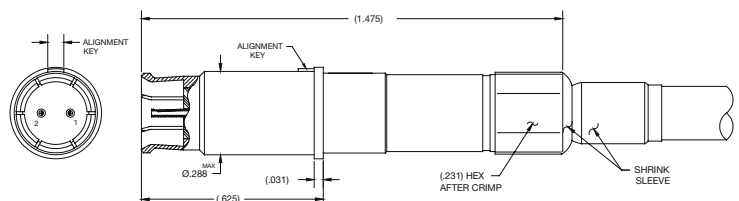

Size 8 Contact Layouts

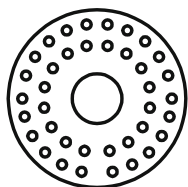

17-2 T/Q
1 #8
38 #22D

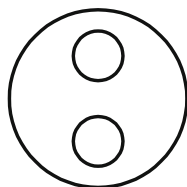

17-82 T/Q
2 #8

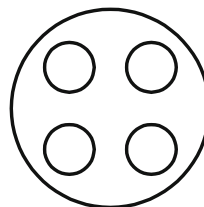

19-4 T/Q
4 #8

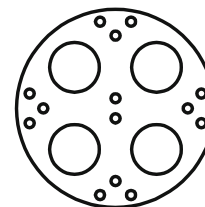

19-18 T/Q
4 #8
14 #22D

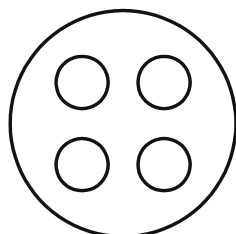

21-75 T/Q
4 #8

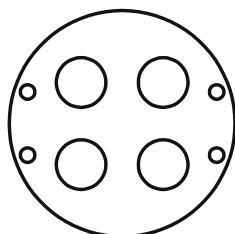

21-4T4 T/Q
4 #8
4 #22D

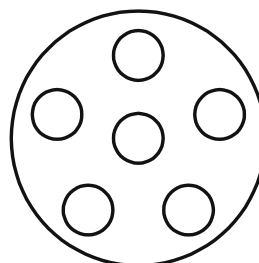

23-6 T/Q
6 #8

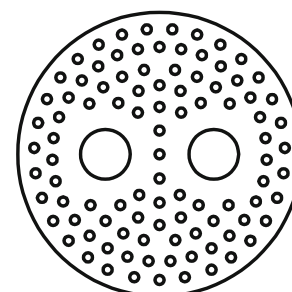

25-7 T/Q
2 #8
97 #22D

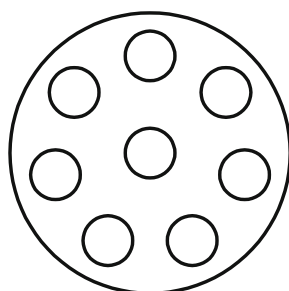

25-8 T/Q
8 #8

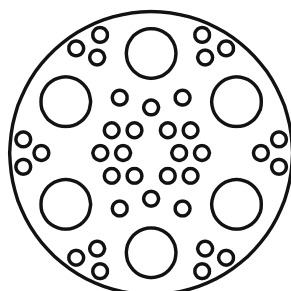

25-17 T/Q
6 #8
36 #22D

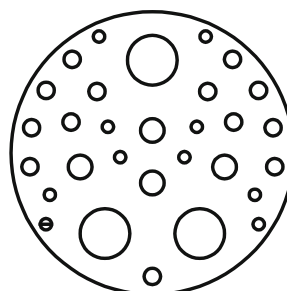

25-20 T/Q
3 #8 / 13 #16
4 #12 / 10 #20

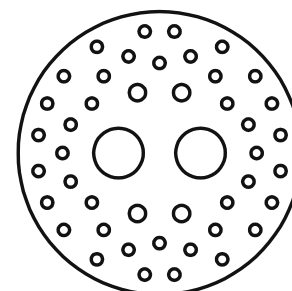

25-46 T/Q
2 #8
4 #16
40 #20

Notes:

- Size #8 Twinax/Quadrax (T/Q) Cavities are Anti-Rotational
- Size #8 Twinax/Quadrax contact cavities are common ground to the connector shell with a ground resistance of 10 milliohms maximum or insulated from common ground. Consult factory for details, please specify preference (common ground or insulated).
- Mixed signal contacts are insulated from common ground. Consult factory for unique grounding and/or filtering requirements.
- Use removal tool M81969/14-12 to remove size 8 contacts.

Smiths Interconnect provides specialty, enhanced performance connectors and cable assemblies and as such does not currently offer circular, rack and panel, or D-subminiature connectors that are listed on military standard Qualified Products Lists (QPL) per applicable detail specification sheets. Smiths Interconnect's connectors are fully interchangeable with applicable QPL products and meet the applicable requirements of all military standards listed in this catalog.

Size 10 Quadrax/Twinax

Size 10 Quadrax Pin Contact 100 Ohm

Part Number	Cable Type	Cable
018835-2100	Differential Quadrax	540-1229-000

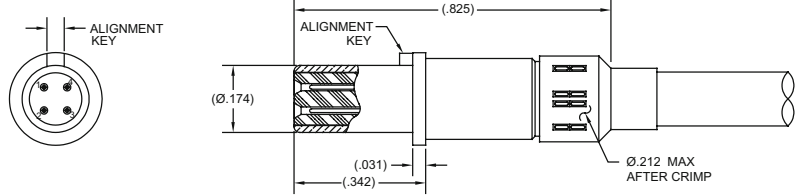

Size 10 Quadrax Socket Contact 100 Ohm

Part Number	Cable Type	Cable
018935-2100	Differential Quadrax	540-1229-000

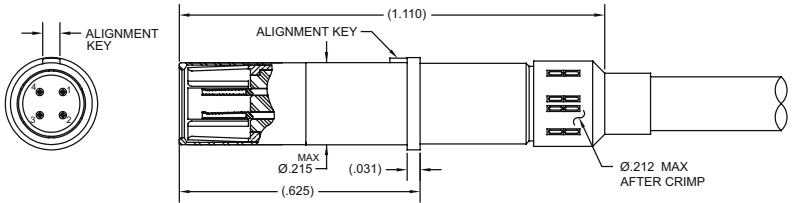

Size 10 Twinax Pin Contact 100 Ohm

Part Number	Cable Type	Cable
018834-2100	Differential Twinax	540-1210-000

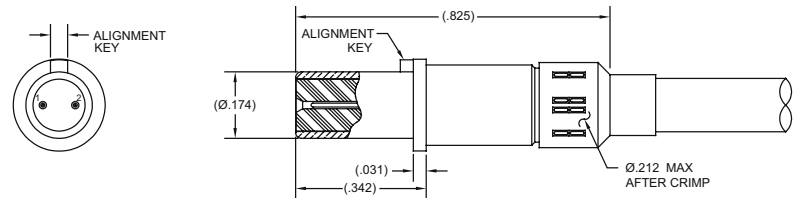

Size 10 Twinax Socket Contact 100 Ohm

Part Number	Cable Type	Cable
018934-2100	Differential Twinax	540-1210-000

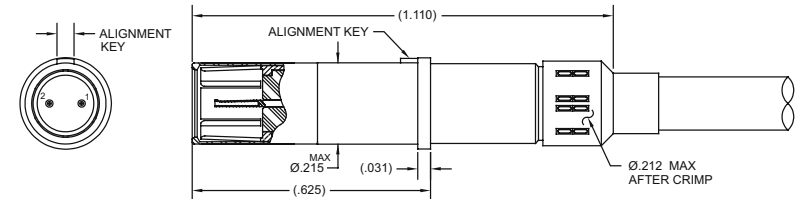

Size 10 Quadrax/Twinax

Size 10 PC Tail Receptacle

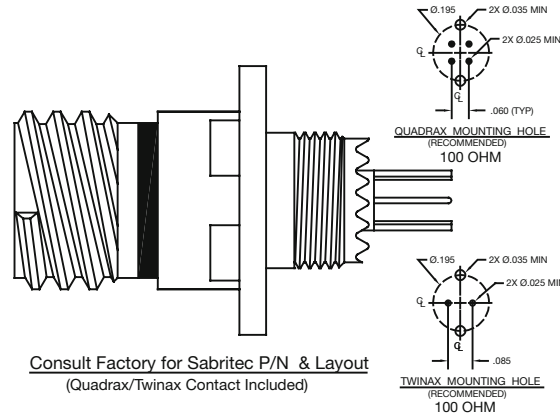

Size 10T/QX Twinax/Quadrax Contact Layouts For Standard MIL-DTL-38999 Shells

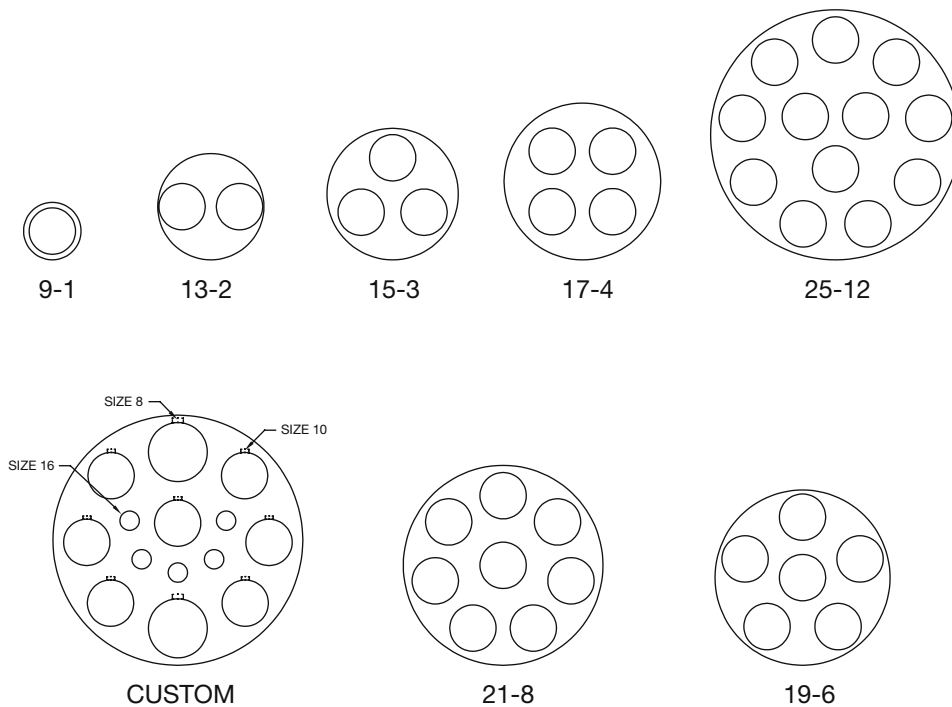

Notes:

- Arrangements are unique Smiths Interconnect layouts designed for MIL-DTL-38999 connector formats
- Twinax/Quadrax contact cavities are common ground to the connector shell
- Size 10 Twinax/Quadrax (T/QX) cavities are anti-rotational
- To remove Size 10 Twinax/Quadrax contacts use removal tool M81969/14-05

Quadrax Connectors

MIL-DTL-38999 Size 11 Pin Insert Quad Plug to Plug Cable Assembly

Y	Polarization	Part Number	Cable Type	Cable
1	N	02990Y-2XXX	Differential Quad	540-1138-000
2	A	02990Y-3XXX	Differential Quad	540-1143-000
3	B			
4	C			
5	D			
6	E			

Y = Connector Polarization
XXX = Cable Length in Inches

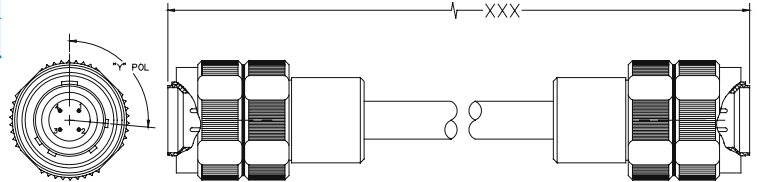

MIL-DTL-38999 Size 11-4 Connector Saver Quad Configuration

Part Number	Polarization
013500-4100	N
013500-4101	A
013500-4102	B
013500-4103	C
013500-4104	D
013500-4105	E

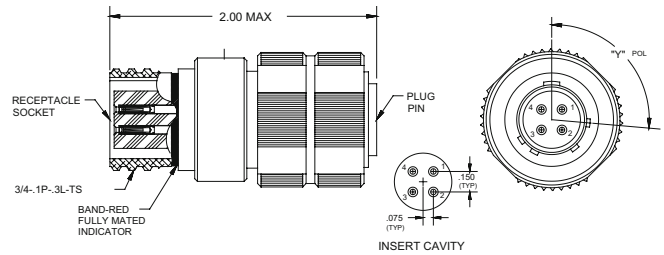

MIL-DTL-38999 Size 25 Four Way Socket Insert Quad Plug

Y	Polarization	Part Number	Cable Type	Cable
1	N	01340Y-2000	Differential Quad	540-1138-000
2	A	01340Y-2001	Differential Quad	540-1143-000
3	B			
4	C			
5	D			
6	E			

Y = Connector Polarization
Please specify cable length when ordering

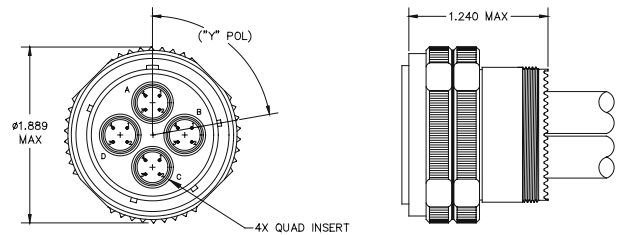

Box Mount Receptacle Pin Insert 25-8 PT* to 8 R/A Twinax Cables to Open Lead

Y	Polarization	Part Number	Cable Type	Cable
1	N	02370Y-1XXX	Differential Twinax	540-1099-000
2	A			
3	B			
4	C			
5	D			
6	E			

Y = Connector Polarization
XXX = Cable Length in Inches
Please specify cable length when ordering

* Connector Receptacle is supplied fully loaded with Twinax pin contacts terminated to Differential Pair Twinax cable to open lead (all cavities included).

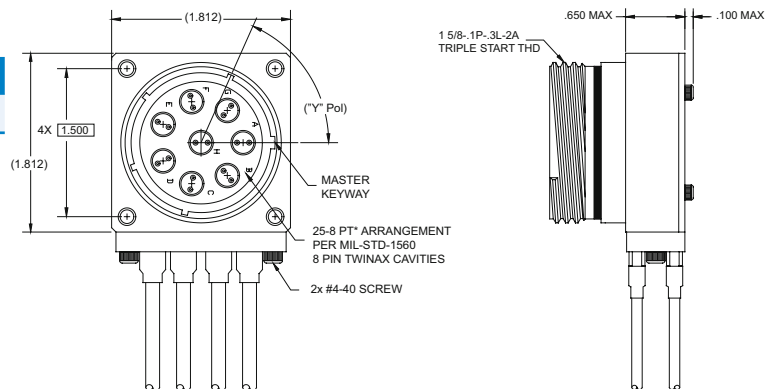

Quadrax and Twinax Connectors

How to Order



1 Prefix	
2 Series	A I B III C IV
3 Shell Style	J Jam Nut (Rear Mount) W Wall Mount (Front or Rear Mount) P Plug
4 Material/Plating	C Aluminum Alloy/ Cadmium over Nickel N Aluminum Alloy/ Electroless Nickel S Stainless Steel/Passivated C C Composite/Cadmium over Nickel C N Composite/Electroless Nickel Consult factory for alternate plating options
5 Shell Size	9 Thru 2 5
6 Insert Arrangements	See page 5 for Size 8 layouts See page 7 for Size 10 layouts
7 Contact Type	P Pin S Socket
8 Contact Termination	P PC Tail C Crimp
9 Polarization	N, A, B, C, D, E

Notes:

- Twinax/Quadrax Crimp Contacts are sold separately.
- Twinax/Quadrax PC Contacts are included.
- Smiths Interconnect's connectors are fully interchangeable with all slash sheet part numbers. Smiths Interconnect does not, however, offer standard QPL slash sheet part numbers for MIL-DTL circular and rack & panel connectors because of the application specific nature of Smiths Interconnect's product offerings.

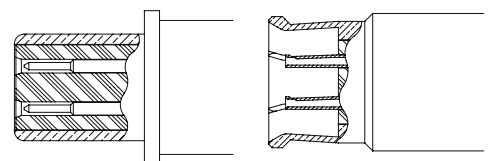

Quadrax Reverse Gender Interface

Cable Assembly

How to Order



1 Connector #1

2 Cable Group #	Flexible Twinax	Differential Twinax	Differential Quadrax
	1 =M17/176-00002	6 =540-1099-000	9 =540-1138-000
	2 =540-1086-000	7 =540-1114-000	10 =540-1143-000
	3 =540-1161-000	8 =540-1153-000	36 =540-1183-000
		34 =540-1167-000	37 =540-1235-000
		38 =540-1210-000	42 =540-1209-000
		39 =540-1236-000	41 =540-1229-000
3 Connector #2	OL for Open Lead		

4 Cable Length in Inches (XXX)

Flexible Twinax Cables				
Cable Group	Cable Designation	Impedance (Ohms)	Jacket	Conductor (DIA)
1	M17/176-00002	77	0.129"	0.024"
2	540-1086-000	98	0.143"	0.019"
3	540-1161-000	100	0.130"	0.024"
Differential Pair Twinax Cables				
6	540-1099-000	Differential: 150 Sig. to Shield: 75	0.097" x 0.160"	0.014" Stranded
7	540-1114-000	Differential: 150 Sig. to Shield: 75	0.138" x 0.224"	0.020" Solid
8	540-1153-000	Differential: 100 Sig. to Shield: 50	0.085" x 0.130"	0.019" Stranded
34	540-1167-000	Differential: 100 Sig. to Shield: 50	0.117" x 0.160"	0.0233" Stranded
38	540-1210-000	Differential: 100 Sig. to Shield: 50	0.132"	0.019"
39	540-1236-000	Differential: 150 Sig. to Shield: 75	0.191"	0.019"
Differential Quadrax Cables				
9	540-1138-000	Differential: 150 Sig. to Shield: 75	0.290"	0.032"
10	540-1143-000	Differential: 150 Sig. to Shield: 75	0.190"	0.020"
36	540-1183-000	Differential: 100 Sig. to Shield: 50	0.160"	0.024"
37	540-1235-000	Differential: 100 Sig. to Shield: 50	0.108"	0.012"
40	540-1209-000	Differential: 100 Sig. to Shield: 50	0.190"	0.029"
41	540-1229-000	Differential: 100 Sig. to Shield: 50	0.137"	0.019"

Global Support

Americas

- Kansas City, KS
+1 913 342 5544
info.us@smithsinterconnect.com
- Tampa, FL
+ 1 813 901 7200
info.tampa@smithsinterconnectinc.com
- Milpitas, CA
+1 408 957 9607 x-1125
info.us@smithsinterconnect.com
- Kirkland, QC, Canada
+1 514 842 5179
info.us@smithsinterconnect.com
- Salisbury, MD
+1 800 780 2169
info.us@smithsinterconnect.com

Europe

- Deggendorf, Germany
+49 991 250 120
info.de@smithsinterconnect.com
- Rouen, France
+33 2 3296 9176
info.fr@smithsinterconnect.com
- Dundee, UK
+44 1382 427 200
info.dundee@smithsinterconnect.com
- Genova, Italy
+39 0 10 60361
info.it@smithsinterconnect.com

Asia

- Bangalore, India
+91 080 4241 0529
info.in@smithsinterconnect.com
- Singapore
+65 6846 1655
info.asia@smithsinterconnect.com
- Mianyang, China
+86 816 231 5566
HSICSR@hf-smiths.com
- Suzhou, China
+86 512 6273 1188
info.asia@smithsinterconnect.com
- Shanghai, China
+86 21 2283 8008
info.asia@smithsinterconnect.com

more > [smithsinterconnect.com](https://www.smithsinterconnect.com) | [in](#) [twitter](#) [youtube](#)