

# SpaceABLE

10G SL Series and 28G SL Series

Radiation-resistant optical transceivers

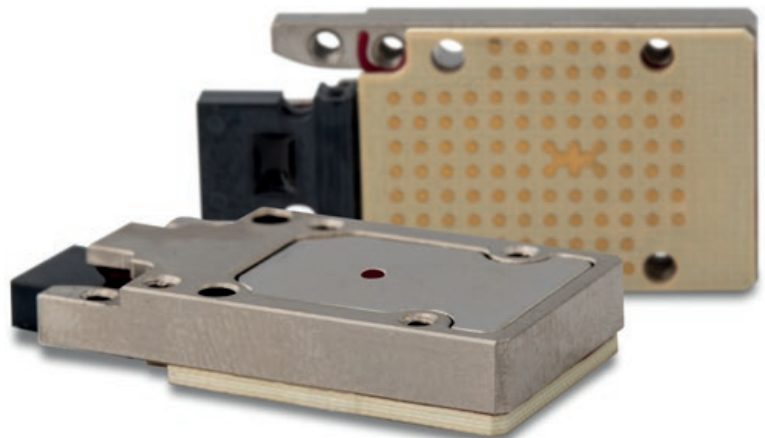
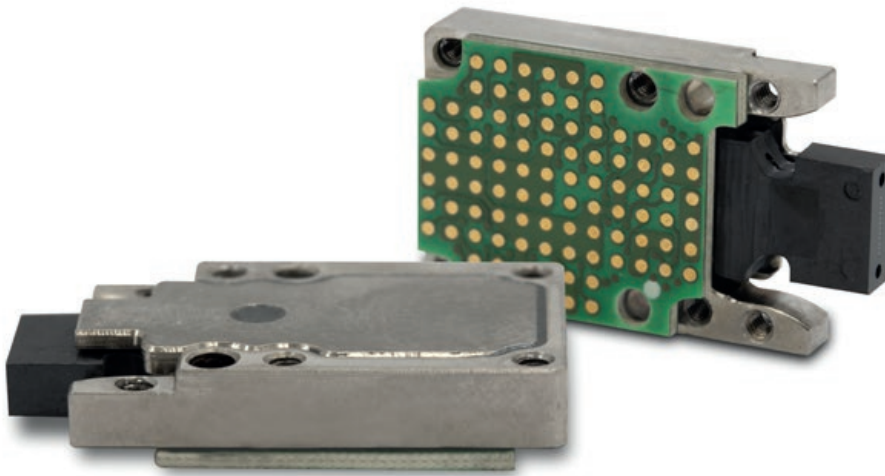

**Radiation**  
**resistant**

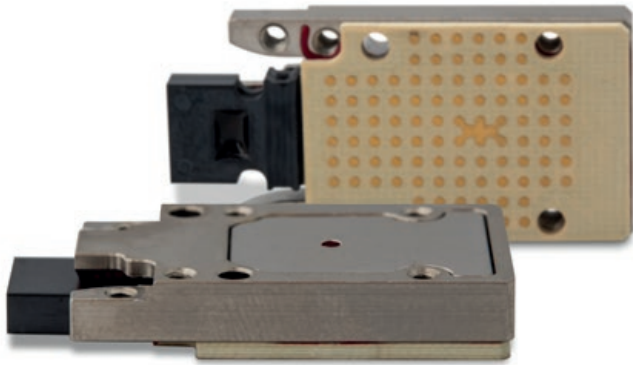

## The SpaceABLE 10G SL Series and 28G SL Series radiation-resistant onboard embedded optical transceiver modules offer radiation hardness, robustness, longevity, and high I/O density.

The SpaceABLE® line of products with their intrinsic radiation resistance, are well suited to provide optical interconnect within space vehicles. These devices are extremely rugged and deliver bandwidth in excess of 300 Gbps in a chip size part.

The SpaceABLE 10G and 28G SL Series low profile screw-in modules mount to the board via an LGA connector (interposer).

### Radiation resistance

All SpaceABLE radiation resistant transceivers are engineered to withstand radiation doses > 100 krad (Si). Furthermore, all our devices are tested following ECSS process and lot acceptance. Component pre-screening can be done for every batch of transceivers sold for this application.

Radiation-resistant,  
low-SWaP,  
multichannel optical  
transceivers for space  
applications.

### Key advantages

- **Rugged:** withstand radiation doses > 100 krad (Si) and qualified per MIL-STD 883 shock and vibration.
- **Expected life:** up to 20 years.

	10G SL	28G SL	
		4TRX	12TX/12RX
Height (mm)	5.5*	6*	
Bandwidth (Gbps/channel)	10.3125	28	
Sensitivity (dBm for BER 10 <sup>-12</sup> )	-9	7 dB link budget	
Operating temperature (°C)	-40 to 85		-10 to 75
Power consumption (mW/channel)	115	160	

\* with interposer

### Configurations

#### 10G SL Series

- 4TRX (40G, full duplex)
- 12TX or 12RX (120G, half duplex)

#### 28G SL Series

- 4TRX (100G, full duplex)
- 12TX or 12RX (300G, half duplex)

### Applications

- High-throughput communication satellites
- LEO satellite constellations
- GEO satellites
- Board-to-board and payload-to-payload connections
- High I/O density, high BW communication links

#### Actual-size illustration

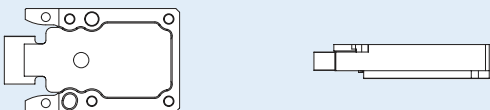

Actual size of SpaceABLE 10G SL 4TRX, 12TX, and 12RX.

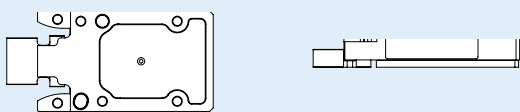

Actual size of SpaceABLE 28G SL 4TRX, 12TX, and 12RX.

## SpaceABLE features

- Multimode 850 nm wavelength laser
- Standard MT parallel fibre connector
- Equalizer, pre-emphasis, adjustable output
- Monitoring: LOS, RSSI, temperature, etc.
- Mounting: LGA interposer

	10G SL	28G SL
Reach on OM3 ribbon fibre (m)	Up to 100	Up to 60

## Space qualification tests summary

- **Proton testing:** Total non-ionizing dose (TNID)
- **Heavy ion testing:** Single event effect & latch-up (SEE and SEL)
- **Gamma Ray using Cobalt-60:** Total ionizing dose (TID)
- **Random vibration:** NASA GEVS, GSFC-STD-7000A
- **TVAC:** Vacuum < 5E-5 hPa
- **Outgassing:** ECSS-Q-ST-70-02C

## Optical connection

### MicroClip

The Reflex Photonics technology MicroClip™ is a small, lightweight clip that connects an MT connector cable to the SpaceABLE. These modules, when paired with the MicroClip have proven they can withstand a 1 kg live traffic fibre pull test (10 Gbps/channel) on a 12-fibre ribbon cable pigtail without any signal performance degradation.

In addition, the MicroClip has completed environmental testing including temperature cycling and vibration for space applications.

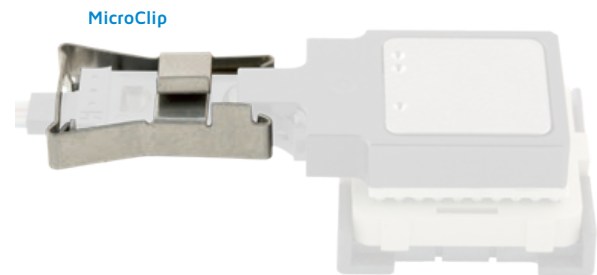

MicroClip MT ferrule shown on a SpaceABLE 10G SM module.

## Electrical connection

### Interposers

LGA interposers are used with all SL Series modules. They provide a secure and flexible low-profile electrical interface with the board, and position the SpaceABLE on the board with two alignment pins.



LGA interposers.

# SpaceABLE ordering information

## SpaceABLE 10G SL Series

Part Number	Product Description	Channels or Lanes	Bandwidth (Gbps/ch.)	Sensitivity (dBm)	Mounting	Operating Temp. (°C)
SLT12P918533002	SpaceABLE 12TX transmitter	12	10.3125	n.a.	RoHS LGA	-40 to 85
SLR12P918530102	SpaceABLE 12RX receiver	12	10.3125	-9	RoHS LGA	
SLX04P918532102	SpaceABLE 4TRX transmit/receive	4+4	10.3125	-9	RoHS LGA	

## SpaceABLE 28G SL Series

Part Number	Product Description	Channels or Lanes	Bandwidth (Gbps/ch.)	Sensitivity (dBm)	Mounting	Operating Temp. (°C)
SLX04P528532102	SpaceABLE 28G SL 4TRX transmit/receive	4+4	25.7	-6	RoHS LGA	-40 to 85
SLT12P928533002	SpaceABLE 28G SL 12TX transmitter	12	25.7	n.a.	LGA	-10 to 75
SLR12P928530102	SpaceABLE 28G SL 12RX receiver	12	25.7	-6	LGA	

See datasheets for accessory part numbers including interposers, fibre cables, and dust caps.

## SpaceABLE dimensions

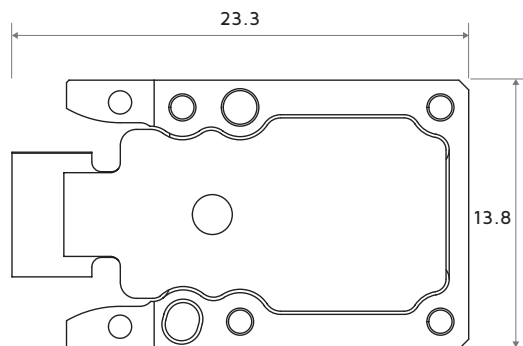

Drawing of SpaceABLE 10G SL 4TRX, 12TX, and 12RX (measurements given in mm).

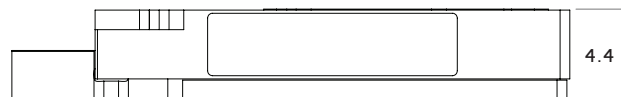
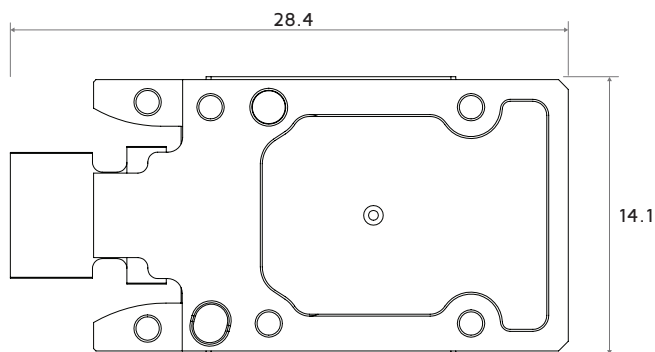

Drawing of SpaceABLE 28G SL 4TRX, 12TX, and 12RX (measurements given in mm).

more > [smithsinterconnect.com](https://www.smithsinterconnect.com) | [in](#) [twitter](#) [youtube](#)